

Pro3 Series 3D Printer

User Manual

* Please review this entire manual before operating the printer.

WARNING

This is a class A product. In a domestic environment this product may cause radio interference in which case the user may be required to take adequate measures.

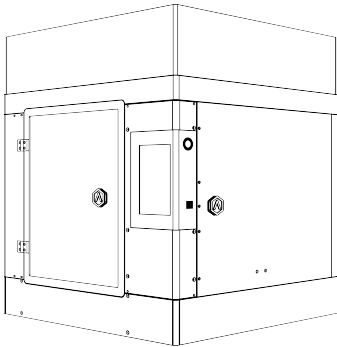

Pro3

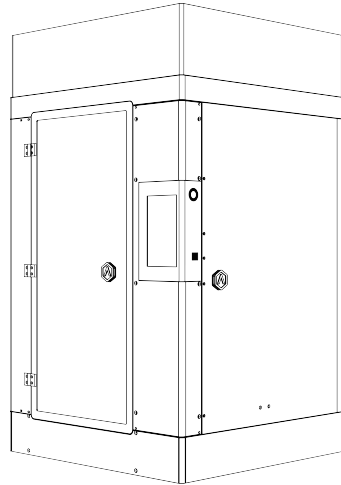

Pro3 Plus



www.raise3d.com

The contents of this User Manual maybe updated overtime. For the latest version, scan the QR code or visit the link below.



<https://support.raise3d.com/Pro3-Series/user-manual-26-1399.html>

CONTENTS

A. Safety.....	02
B. FCC Statement.....	07
C. Technical Specifications	08
D. List of Parts.....	09
E. Safety Marks	12
F. Hardware Installation	15
G. ideaMaker Installation.....	20
H. ideaMaker Initial Settings.....	23
I. Using ideaMaker.....	24
J. Dual Extruder Printing	26
K. Dual Color Printing	31
L. User Interface	37

A. Safety

Read the following information to ensure safe usage of the appliance.

1 General information

- Any damage or loss resulting from failure to follow the directions or warnings provided in this manual will not be covered under the product warranty. To ensure the printer is used safely and efficiently, carefully read through the entire manual.
- This manual is intended for the installer and the user of the printer. Follow the safety instructions and warnings.
- Please keep the instruction manual and the product information safe for future reference or for the next owner.
- When unboxing the printer it should be checked for any damage that may have happened in transit.
- If any damage is observed the printer should not be powered on before contacting support.
- If you have any questions, please contact our local service center or distributors.

2 Intended use

Proper use gives information regarding the correct and safe usage of the printer. The printer should only be used:

- In accordance with the information provided in this manual.
- In a well ventilated and dry environment.
- In an environment between 0-35°C.
- In an environment with relative humidity below 95%(when at a temperature of 25°C).
 - Ambient temperature of 0-35°C;
 - Relative humidity of the air is below 95% (when the temperature is 25°C).

3 Restriction on user group

- Avoid risks to children and vulnerable persons.
- Children must not play with the printer.
- Keep children and pets away from the printer.

4 Safe installation

Take note of the safety instructions when installing the printer.

- ⚠ WARNING – Risk of electric shock!
- Improper installation is dangerous.

A. Safety

- Connect and operate the printer according to the specifications on the rating plate.
- Connect the printer to a power supply with an alternating current only via a properly installed outlet with grounding.
- The protective conductor system of the domestic electrical installation must be properly installed. The installation must have a sufficiently large cross-section.
- Please ensure that the power supply system (current, voltage, and cables) can meet the normal load requirements of the printers.
- Please ensure that the power supply system (current, voltage and cables) can meet the normal load requirements of the electrical printers.
- Never equip the printer with an external switching device, e.g. a timer or remote control.
- When installing the printer, check that the power cable is not trapped or damaged.
- Select the fuse according to the fuse safety identification requirements.
- The power plug and the socket must match, the grounding blade must work properly, and the body must be properly grounded.
- **Damaged insulation of the power cord is dangerous.**
 - Never let the power cord come into contact with hot printer parts or heat sources.
 - Never let the power cord come into contact with sharp points or edges.
 - Never kink, crush or modify the power cord.
- **Stop the machine and ensure the outlet for the printer is properly grounded.**
- **If you have any questions, consult a professional electrician.**

 **WARNING – Risk of fire!**

- **It is dangerous to use an extended power cord or unapproved adapter.**
 - Do not use extension cables or multiple socket strips.
 - If the power cord is too short, contact Customer Service.
 - Only use adapters approved by the manufacturer.

 **WARNING – Risk of injury!**

- **Careful when lifting the machine. The weight of the machine may cause injury when lifted.**
 - Do not lift the machine on your own.

 **WARNING – Risk of suffocation!**

- **Keep packaging material away from children. Do not allow children to put packaging material over their heads or wrap themselves up in it as it could lead to suffocation.**

A. Safety

- Do not let children play with packaging material.

CAUTION – Risk of injury!

- The printer may vibrate when in use.
 - Place the printer on a clean, even, solid surface.
- Incorrectly laid tubes and power cords may result in a tripping hazard.
 - Lay tubes and power cords to avoid creating a tripping hazard.
- If the printer is moved by holding onto protruding components, such as the printer door, the parts may break off.
 - Do not move the device by holding onto protruding parts. Holding the machine by a protruding part, such as the door, may result in the part breaking off the machine.

CAUTION – Risk of cutting!

- Touching sharp edges on the printer may lead to cuts.
 - Do not touch the sharp edges on the printer.
 - Wear protective gloves when installing and transporting the printer.

Safe use

Follow these safety instructions when using the machine.

WARNING – Risk of electric shock!

- A damaged printer or power cord is dangerous.
 - Never operate a damaged machine.
 - Never pull on the power cord to unplug the machine. Always unplug the machine at the mains.
 - If the machine or the power cord is damaged, immediately unplug the power cord.
 - Call Customer Service.
 - Repairs to the printer should only be completed by trained specialist staff.
- An ingress of moisture can cause an electric shock.
 - Never expose the machine to intense heat or humidity.
 - Do not use steam cleaners or sprays to clean the machine.

WARNING – Risk of harm to health!

- If a child locks themselves in the machine, their life is at risk.
 - Do not install the machine behind a door as this may obstruct the machine door or prevent it from opening.
 - With redundant appliances, unplug the power cord and cut through the cord.

A. Safety

WARNING – Choking Hazard!

- This machine contains many small parts and pieces. Do not allow children to breathe in or swallow small parts.
 - Keep small parts away from children.
 - Do not let children play with small parts.

CAUTION – Risk of injury!

- The printer's lid is not designed to support weight and will likely break if stood on.
 - Do not stand or climb on the printer.
- The appliance may tip over if you sit on or lean against the open door.
 - Do not sit on or lean against the printer door.
 - Do not place any objects on the printer door.
- Reaching into the chamber while the three-axis system is still moving may cause hand injuries.
 - Wait for the three-axis system to come to a complete stop before reaching inside.
- The spatula provided in the accessory box has a sharp edge. If the spatula is incorrectly used the user may be injured.
 - Do not touch the edge of the spatula.
 - Keep children away from the spatula.
- Some parts in the printer are sharp and may cause injury.
- To avoid injury, refer to the operational guide when removing printed parts from the build plate.

WARNING – Risk of burns!

- When operating or printing at high temperatures, the shell of the printer becomes hot.
 - Do not touch the shell of the printer when it is hot.
 - Keep children away from the printer when it is hot.

WARNING – Risk of scalding!

- When operating or printing at high temperatures, the print bed becomes hot.
 - Do not touch the print bed when it is hot.
 - Please operate with the heat-resistant gloves in the attachments box.
 - Keep children away from the print bed when it is hot.
- When operating or printing at high temperatures, the hot end becomes hot.
 - Do not touch the hot end when it is hot.
 - Please operate with the heat-resistant gloves in the attachments box.
 - Keep children away from the hot end when it is hot.

A. Safety

6 Safe Maintenance

Take note of the safety instructions when performing maintenance work on the printer.

 **WARNING** – Risk of electric shock!

■ Improper repairs are dangerous.

- Repairs to the printer should only be carried out by trained specialist staff.
- Only use the manufacturer's original spare parts and original accessories when repairing the printer.
- If the printer's power cord is damaged, it must be replaced by the manufacturer, the manufacturer's Customer Service, or a similarly qualified person in order to prevent any risk.

■ Ingress of moisture can lead to electrical shock.

- Do not use a steam cleaner or spray to clean the printer.

 **CAUTION** – Risk of injury!

■ The use of non-original spare parts and non-original accessories is dangerous.

- Only use the manufacturer's original spare parts and original accessories.

B. FCC Statement

This equipment has been tested and found to comply with the limits for a Class A digital device, pursuant to part 15 of the FCC Rules.

These limits are designed to provide reasonable protection against harmful interference when the equipment is operated in a commercial environment.

This equipment generates, uses, and can radiate radio frequency energy and, if not installed and used in accordance with the instruction manual, may cause harmful interference to radio communications.

Operation of this equipment in a residential area is likely to cause harmful interference in which case the user will be required to correct the interference at his own expense.

C. Technical Specifications

Printer	Pro3		Pro3 Plus	
Build Volume (W×D×H)	Single Extruder Print	Dual Extruder Print	Single Extruder Print	Dual Extruder Print
		300×300×300 mm	255×300×300 mm	300×300×605 mm
Machine Size (W×D×H)	620×626×760 mm		620×626×1105 mm	
Electrical	Power Supply Input	100-240 V AC, 50/60Hz 230 V @ 3.3 A		
	Power Supply Output	24 V DC, 600 W		
General	Print Technology	FFF		
	Print Head System	Dual-head with electronic lifting system		
	Filament Diameter	1.75 mm		
	XYZ Step Size	0.78125, 0.78125, 0.078125 micron		
	Print Head Travel Speed	30-150 mm/s		
	Build Plate	Flexible Steel Plate with BuildTak		
	Max Build Plate Temperature	120 °C		
	Heated Bed Material	Silicone		
	Build Plate Leveling	Mesh-leveling with Flatness Detection		
	Filament Run-out Sensor	Available		
	Supported Materials	PLA/ ABS/ HIPS/ PC/ TPU/ TPE/ PETG/ ASA/ PP/ PVA/ Nylon/ Glass Fiber Infused/ Carbon Fiber Infused/ Metal Fill/ Wood Fill		
	Layer Height	0.01 - 0.25mm		
	Nozzle Diameter	0.4 mm (Default), 0.2/ 0.6/ 0.8/ 1.0 mm (Available)		
	Max Nozzle Temperature	300 °C		
	Connectivity	Wi-Fi, LAN, USB port, Live camera		
	Software	Slicing Software	ideaMaker	
Supported File Types		STL/ OBJ/ 3MF/ OLTP		
Supported OS		Windows/ macOS/ Linux		
Machine Code Type		GCODE		
Printer Controller	User Interface	7-inch Touch Screen		
	Network	Wi-Fi, Ethernet		
	Power Loss Recovery	Available		
	Screen Resolution	1024×600		
	Motion Controller	Atmel ARM Cortex-M4 120MHz FPU		
	Logic Controller	NXP ARM Cortex-A9 Quad 1 GHz		
	Memory	1 GB		
	Onboard Flash	8 GB		
	OS	Embedded Linux		
	Ports	USB 2.0*2, Ethernet*1		

D. List of Parts

Pro3

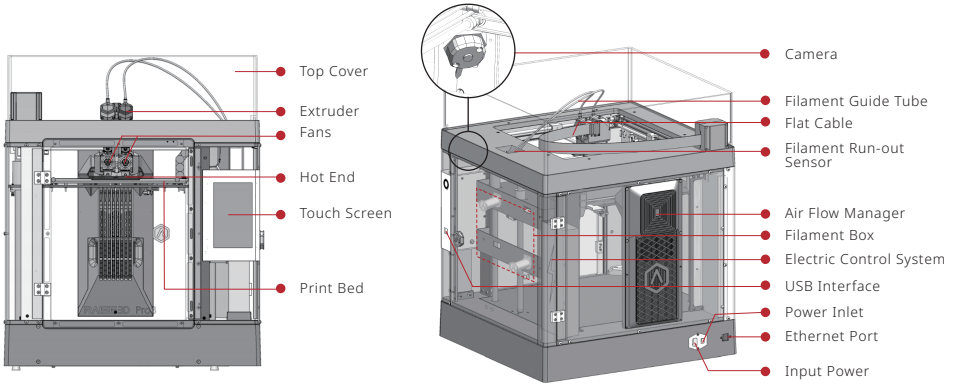

Pro3 Plus

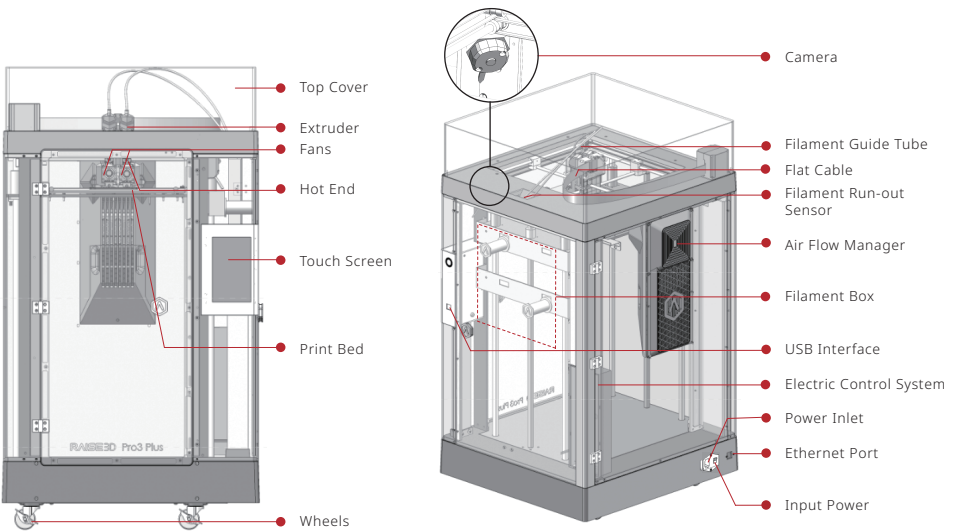

D. List of Parts

A. Top Cover

The upper cover of the printer.

B. Extruder

The part extruding filament to the hot end; brand-new unitized extruders, which are more convenient to disassemble; a dual extrusion structure is adopted to adapt to a variety of filaments.

C. Fans

Used to cool the heat down.

D. Hot End

The part that melts filaments; with the quick-release design, even beginners can quickly remove the hot end within one minute; it is more convenient to repair the hot end after removing it.

E. Touch Screen

To control the printer and check the status of the printer.

F. Build Plate

A plate for printing the model.

G. Camera

Used to observe the operation of the printer.

H. Filament Guide Tube

Protects and guides filaments.

I. Flat Cable

The integrated cable that transmits the signal from the motion controller board to the extruder; a new flat cable is adopted to replace the large drag chain of Pro2 printer, which reduces the weight of the extruder and avoids the sagging of the cross shaft.

J. Filament Run-out Sensor

An automated optical detection system is adopted to detect whether the filaments are sufficient. When the filaments are running out, the printer will automatically stop printing.

K. Air Flow Manager

An air filter manager including a fan and a HEPA filter, which is used to enhance air circulation inside the printer.

D. List of Parts

L. Filament Box

The place where the filament is discharged, which can accommodate 2 rolls of 1kg filaments at the same time.

M. Electric Control System

Stores the motion controller board.

N. USB Interface

2 USB2.0 interfaces.

O. Ethernet Port

RJ45 port to connect the printer to a network.

P. Input Power

AC input and switching.

E. Safety Marks

Hot Surface: The hot surface sign indicates the presence of devices with high temperatures. Always use extra care when working around heated components. Wait half an hour after switching off the printer before handling parts to prevent burned fingers.



Hot parts!

Burned fingers when handling the parts.
Wait one-half hour after switching off before handling parts.

Moving Parts: Please do not put fingers, clothing or hair into gears and other hazardous parts to avoid electric shock, injury, fire, or damage to the device.



This equipment is not intended for use by children.
Avoid touching the media feed opening with the hands, clothing or hair.
Unplug this equipment when not in use for an extended period of time.

High Voltage: The high voltage sign indicates the presence of high voltages. Always stay away from exposed circuitry. It is recommended that all conductors be removed.



Replacement fuse identification and rating markings: Identification of a suitable replacement fuse shall be marked adjacent to the fuse holder.

F10AL 250VAC

Protective Earthing Conductor Terminal: Marked near the protective earthing conductor terminal.



E. Safety Marks

1 Installation

To facilitate operation and maintenance, please keep a proper distance of 50cm on the side of the printer, 80cm on the front, 20cm on the back, and 60cm on the top during installation. No flammable materials are allowed around the installation location.

2 Filament and Electrical Precautions

It is strongly recommended to use Raise3D official filaments and/or default settings for better performance. The Raise3D printer is designed with strong compatibility with filaments. However, please be very careful when using unverified filaments and settings. This may cause abnormal printing tasks or damage the printer.

Please consult Raise3D or authorized dealers in your area for technical support and services.

Warning: The printer belongs to EN55032 Class A. In a residential environment, the printer may cause radio interference.

3 Odor

When the printer is operating, it emits a thermoplastic smell.

NOTE: Please place the printer in a well-ventilated and dry environment.

E. Safety Marks

Electromagnetic Compatibility - EMC

Simplified EU Declaration of Conformity

Raise3D declares that this device is in compliance with the essential requirements and other relevant provisions of Directive 2014/53/EU. Full text of the EU declaration of conformity is available at <https://www.raise3d.com>.

CE Mark Warning

This is a Class A product, in a domestic environment, may cause radio interference, in which case the user may be required to take adequate measures.



AT	BE	BG	CZ	DK	EE	FR
DE	IS	IE	IT	EL	ES	CY
LV	LI	LT	LU	HU	ME	NL
NO	PL	PT	RO	SI	SK	TR
FI	SE	CH	UK	HR		

CE Output power table:

Function	Frequency	Frequency
Wi-Fi	2412-2472 MHz	18 dBm(b)/ 18 dBm(g)/ 13 dBm(HT)
	5150-5250 MHz	19 dBm(a)/ 18.5 dBm(HT20)/ 17.5 dBm(HT40)
	5725-5850 MHz	14 dBm(a)/ 14 dBm(HT20)/ 14 dBm(HT40)

FCC Output power table:

Function	Frequency	Frequency
Wi-Fi	2412-2462 MHz	18.31 dBm(b)/ 15.62 dBm(g)/ 14.9 dBm(HT20)
	5150-5250 MHz	15.36 dBm(a)/ 14.79 dBm(HT20)/ 14.41 dBm(HT40)
	5725-5850 MHz	15.48 dBm(a)/ 14.49 dBm(HT20)/ 14.06 dBm(HT40)

F. Hardware Installation

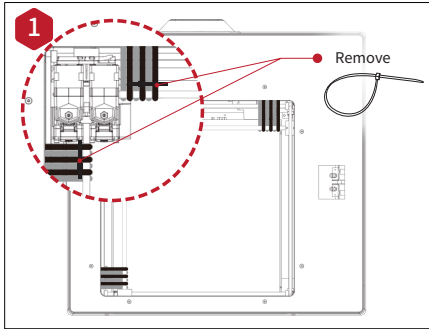

Locate the four shipping zip ties, and remove them.

It is recommended to unclip these as opposed to cutting them. They can be reused if you need to transport your machine in the future.

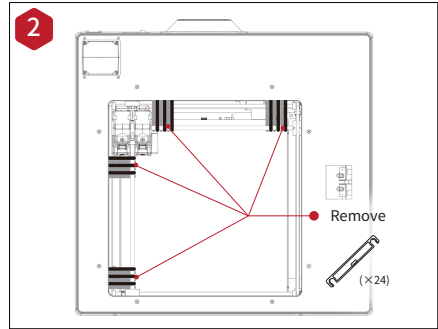

Peel off the yellow stickers and remove the 24 security spacers.

These clips are designed to hold the extruder assembly in place during shipping, and should be saved for future transport. Do not operate the printer with the clips installed.

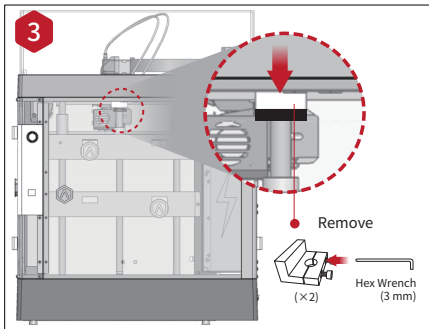

Select the largest of the included hex-head wrenches (3mm), and remove all four hex head security bolts from Z-axis clamps (2 bolts each). These are located on the left and right sides of the printer of the ball screw thread.

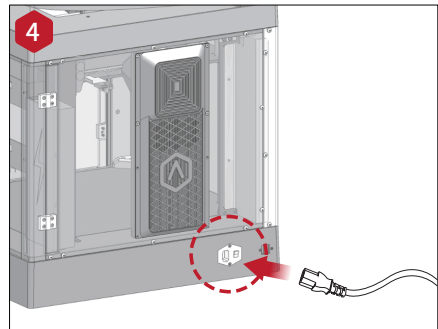

Plug the machine into a wall outlet using the power adapter for your designated country (5 included). Flip the switch to power the unit on.

F. Hardware Installation

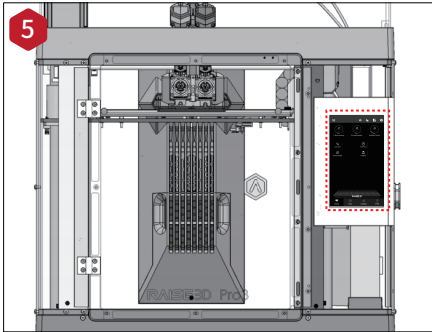

When the touch screen displays the "Home" screen, the printer is ready. Once the unit is powered on, the printer will go through a start-up sequence. Your Raise3D printer will take approximately 60 seconds to boot up. When the touch screen displays the "Home" screen, the printer is ready.

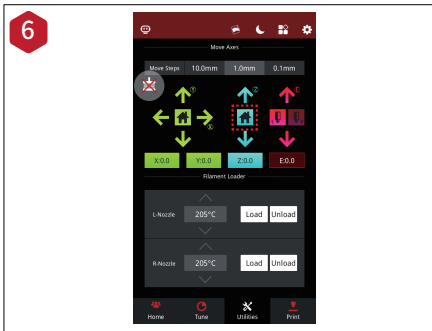

Tap the "Utilities" tab, and press the Z Homing button. Press OK for the print bed to begin to "Home" to the origin position. This will allow you to access your accessory packages.

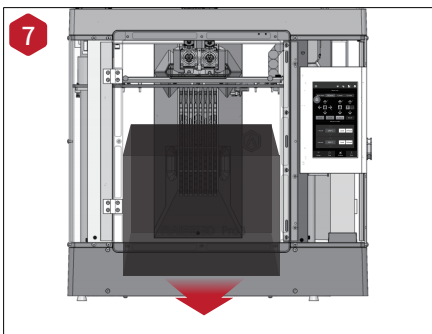

Open the front door, and remove the starter box and filament box from the printer's base. Open these packages, and compare them with the following Raise3D Supplies and Accessories list.

F. Hardware Installation

After removing the starter box, keep following the start-up wizard to finish the network connection, printer settings and RaiseCloud settings.

After the start-up wizard, the printer will carry out 5-steps Offset Calibration, and the whole process takes about 1 hour.

Calibrating the offset value of the printer can increase the printing success rate. Offset Calibration includes Left Z Probe Offset, Right Z Probe Offset, Bed Leveling, R-Nozzle XY Offset and Dual-Color Cube. The calibration process also includes loading the filament. After all calibrations are completed by following the instructions on Raisetouch, subsequent printing can be performed.

NOTE: Once all the basic settings are completed, a window introducing EVE will pop up. Please follow it to move to the next step.

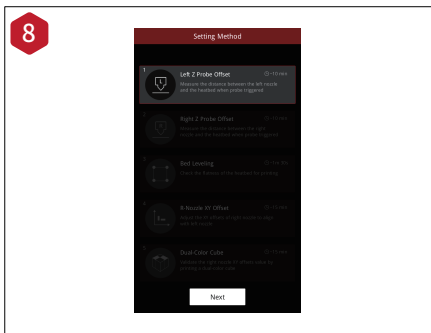

Adjust the distance between the left nozzle and the build plate. If one corner of the bottom plate is a few millimeters higher or lower than the other corner, this gap can be compensated by calibration.

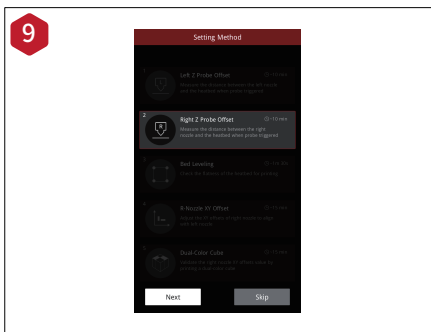

Adjust the distance between the right nozzle and the build plate.

F. Hardware Installation

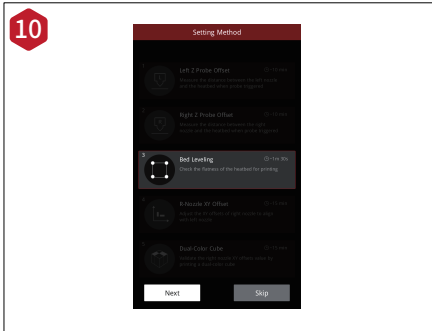

Adjust the flatness of the build plate. Precise flatness helps to get a better bottom surface of the model, avoiding warping or the model detaching from the build surface.

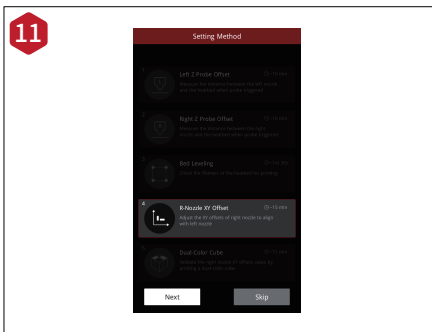

Adjust the matching gap between the left and right nozzles to ensure that the model will not be staggered in dual-color printing.

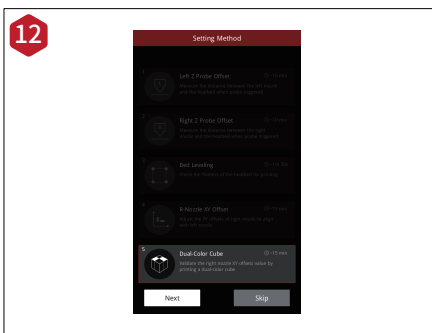

It aims to verify whether the adjustments in the previous four wizards are appropriate.

F. Hardware Installation

Raise3D Supplies and Accessories



Power Cable
(x5)

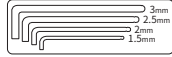

Hex Wrenches

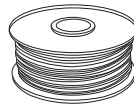

Filament
(x2)



Filament Guide Tube
(x2)



USB Storage



Heat Resistant Gloves



Filament Holder
(x2)



Spatula



Nozzle Cleaning Kit



Tweezers



Thumb Screws
& Other Accessories
(Spare)



0.3 mm Feeler Gauge

G. ideaMaker Installation

The slicing software, ideaMaker, is available on the USB storage device included with your printer. Additional downloads and versions are available online at:

<https://www.raise3d.com/download/>



WINDOWS

- 1 Install ideaMaker, and click "Next".

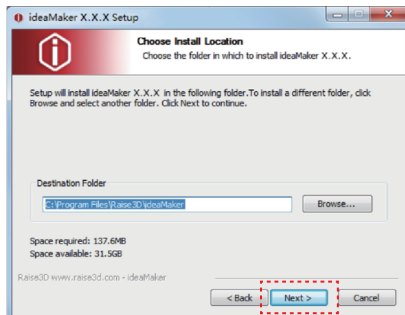

G. ideaMaker Installation

- Follow the instructions provided by the guide, and click "Install". After the installation is finished, click "Next" to go to the next step.

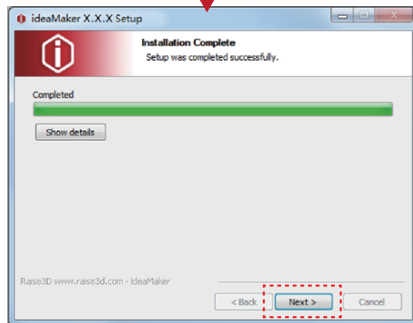
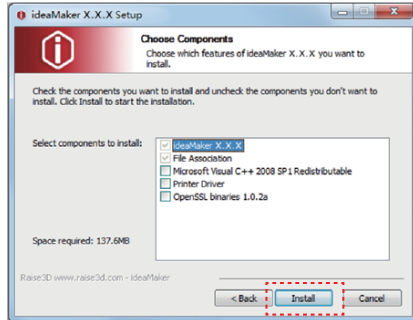

- Click "Finish" and ideaMaker is installed.



G. ideaMaker Installation



MAC OS X

Open the Disk Image for the ideaMaker installer. This is located in the USB storage device included with your printer. Alternatively, you can download the latest version from www.raise3d.com/pages/download#down-im.

Next, drag the ideaMaker icon(left) into the Application folder on the right side.



H. ideaMaker Initial Settings

- 1 When launching ideaMaker for the first time, you will need to select your printer model from the drop-down list, then press "Next".

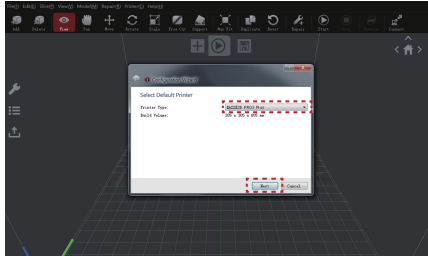

- 2 Select the diameter of your filament. Press "Finish" to finalize the initial settings.
NOTE: ALL Pro3 printers use 1.75 mm filaments.

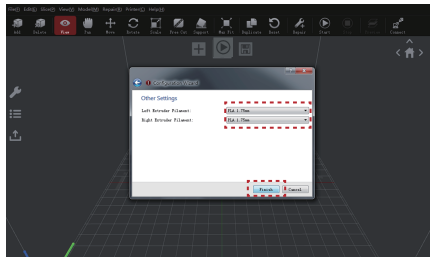

I. Using ideaMaker

- 1 Click the "+" button to import "Giveaway Spinner" included in the USB storage device.

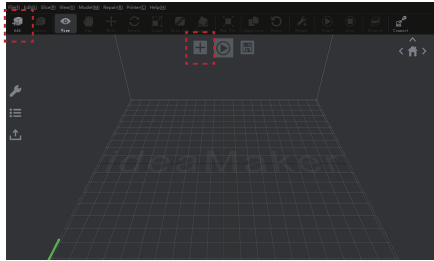

- 2 Click the "Start" button to begin slicing the model.

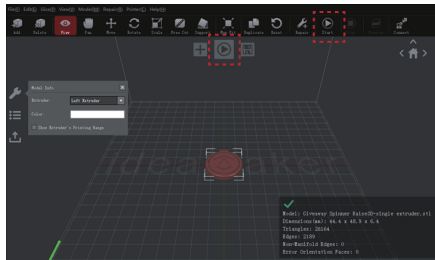

- 3 Confirm that the selected printer type and material are correct, then select the standard slicing template. Click "Edit" to select the type of Platform Addition and the type of Support.

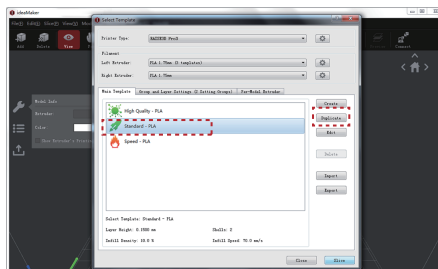

I. Using ideaMaker

- 4 Select your type of Platform Addition and Support in the "Edit" window. Click "Save and Close" to return to the previous menu. Click "Slice" to generate your file.

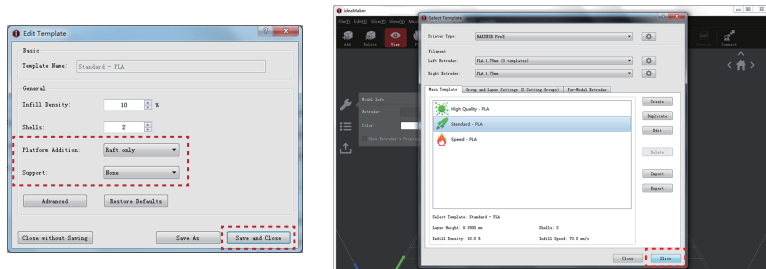

- 5 Save the sliced files (.gcode and .data) by exporting them on the USB storage device.

NOTE: File names that do not conform to the Western Latin character set may not display properly.

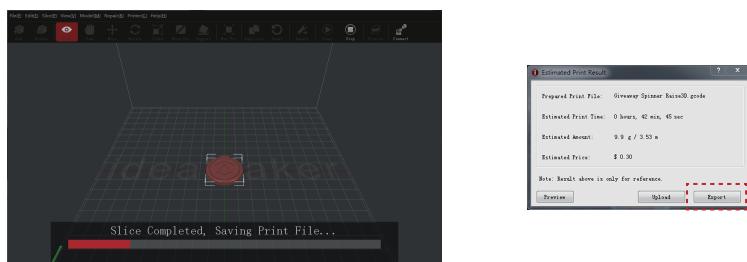

- 6 Confirm that the files are saved and eject the USB storage device.

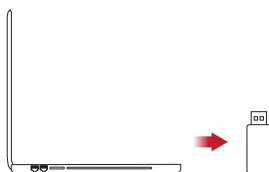

J. Dual Extruder Printing - Loading

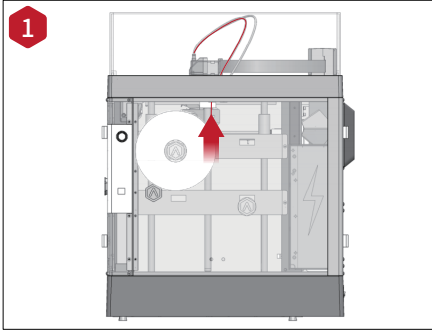

Locate the open end of the filament, and feed it through the guide tube.

NOTE: The operation of the left extruder is the same as that of the right extruder. Here we take the left extruder as an example.

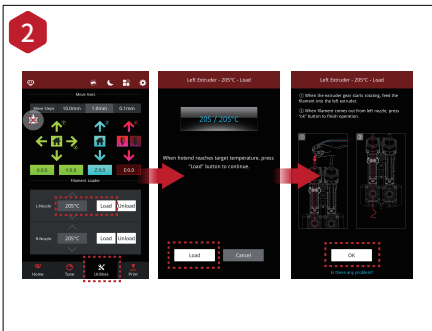

After loading both sides of extruders, press the "Utilities" tab on the bottom of the screen, and set the temperature of the left nozzle to match the requirements of the filament that you are using.

Press the "Load" button, and the printer will begin to heat. When the target temperature is reached, press "Load". Complete the feeding operation according to the instructions on the screen.

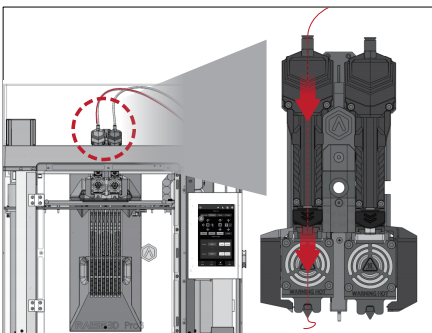

NOTE: This document's instructions are based on the properties of Raise3D PLA filament. This is the standard filament included with your product and it is advised to use Raise3D PLA for testing and initial setup.

J. Dual Extruder Printing - Slicing

- 1 Choose one of the models and set its designated extruder as Left Extruder from the left side "Model Info" window.

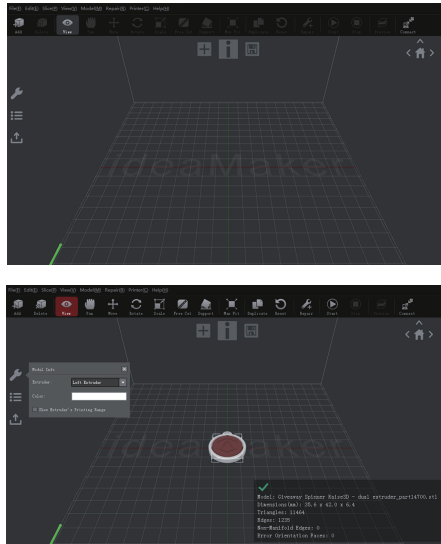

- 2 Choose the other model and set extruder as the Right Extruder using the "Model Info" window.

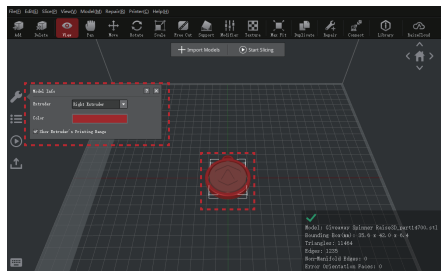

J. Dual Extruder Printing - Slicing

- 3 Click the "Start" or "▶" button to begin slicing the model.

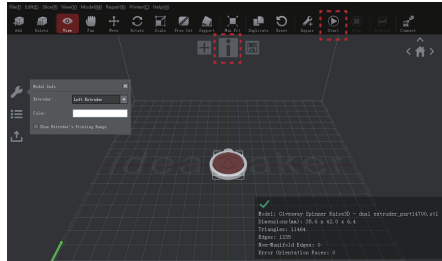

- 4 Confirm your printer type and materials for both extruders, then select the standard sliding template. Click "Edit" to select the type of Platform Addition and the type of Support.

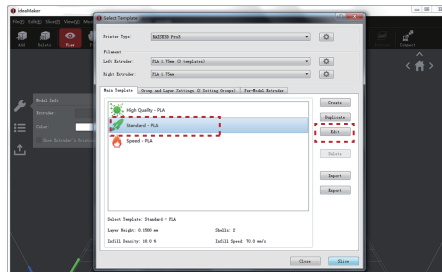

J. Dual Extruder Printing - Slicing

- 5 Select your type of Platform and Support in the "Edit" window. Click "Save and Close" to return to the previous menu. Click "Slice" to generate your file.

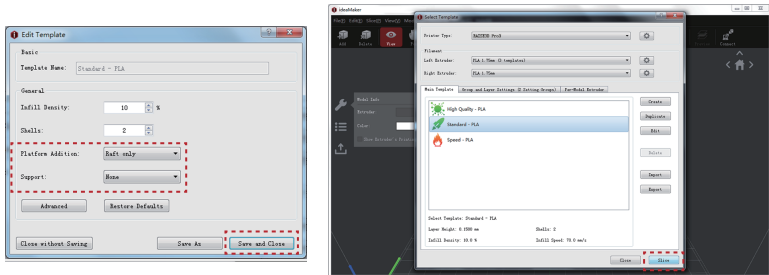

- 6 Save the sliced files (. gcode and .data) to your USB storage device.
NOTE: File names that do not conform to the Western Latin character set may not display properly.

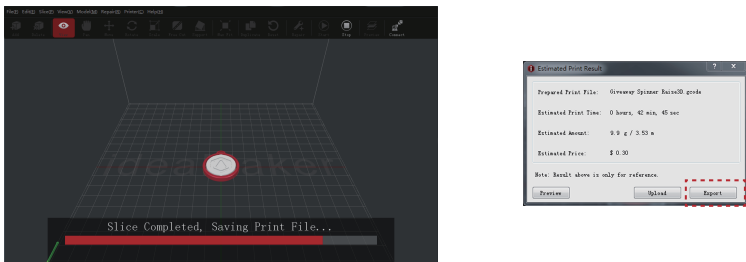

- 7 Confirm that the files are saved and eject the USB storage device.



J. Dual Extruder Printing - Start First Printing

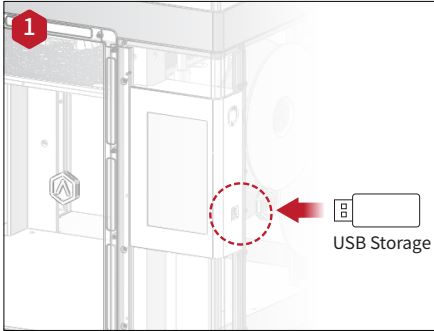

Insert the USB device that contains your sliced model files (.gcode or .data) into the USB slot on the side of the touchscreen.

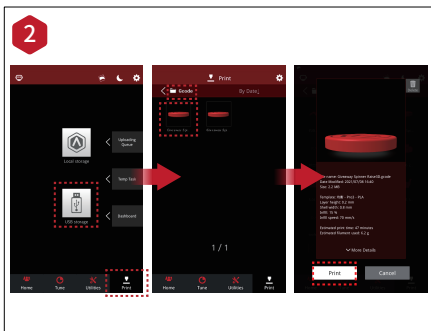

Open the "Print" tab, and choose "USB Storage" to open the file storage path. Select your dual extrusion file to check the printing parameters and settings. Press "Print" to start printing the test file.

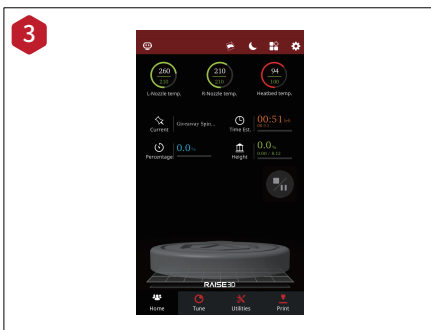

During printing, you can check the status from the "Home" interface on the touchscreen, including the remaining print time and other parameters.

NOTE: The touch screen will display an image of your model on-screen while printing. This image will only be shown when the file is sliced by ideaMaker and the .data file is saved in the USB storage device or uploaded to the screen.

K. Dual Color Printing - Slicing

- 1 To perform higher-level dual-color printing and carry out offset calibration at the same time, please do the following.
Load your filament type for both the left and right extruders.

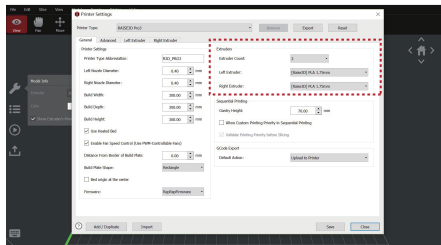
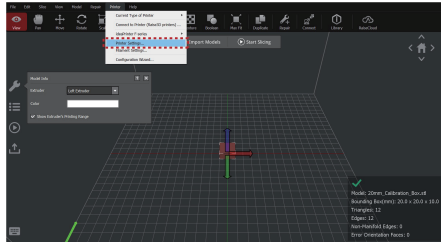

- 2 Each nozzle has a different printing range. To check the printing range of each nozzle when aligning models, tick the "Show Extruder's Printing Range" box.

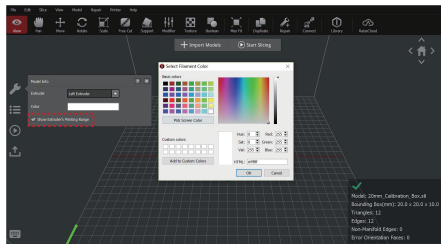

K. Dual Color Printing - Slicing

- 3 Multiple colors are available for different nozzles' printing range.

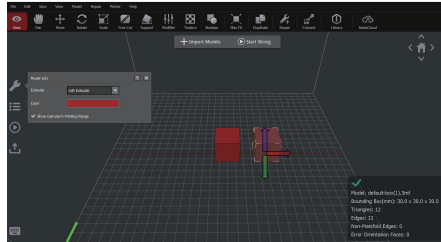

- 4 The "Align Together" feature can align multiple models to their original relative position (as defined during modeling) with each other. It can be located in the "Position" pop-up menu.

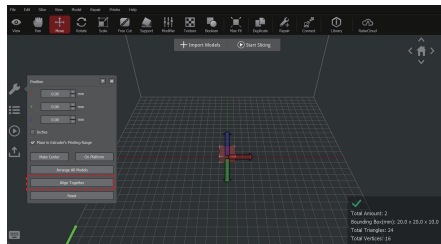

- 5 Select the "Start" button, select your printing template, then open the "Per-Model Extruder" tab to set the nozzle settings per extruder.

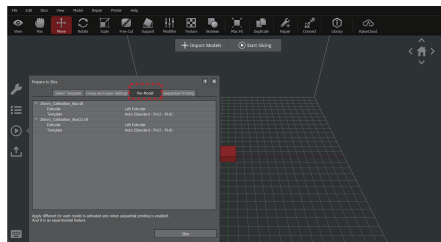

K. Dual Color Printing - Slicing

6 You may also set the extruders through the "Model Info" menu from the main window.

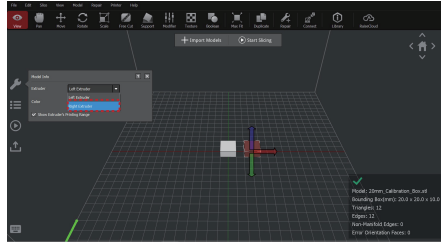

7 Double click a printing template in the "Select Template" windows, and click the "Advanced" button to access the Advanced Settings.

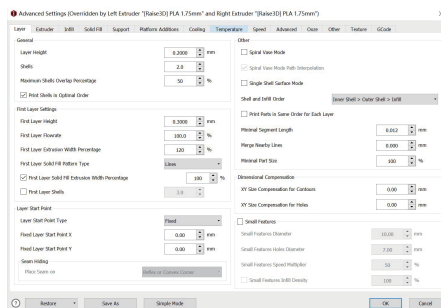
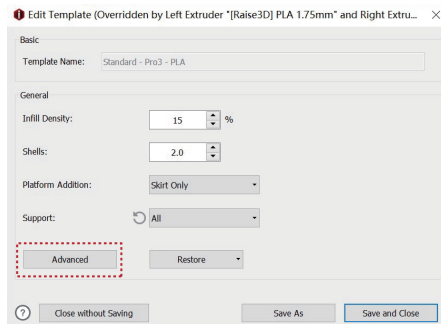

K. Dual Color Printing - Slicing

8 You can specify a nozzle to print support structure under Support tab.

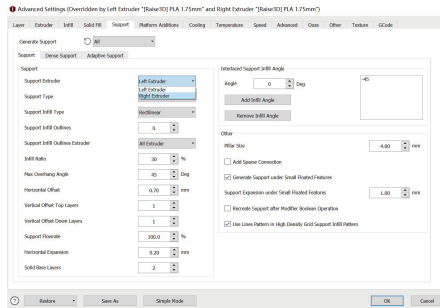

9 ideaMaker is not able to detect when a floating model is being supported by the opposite extruder and will prompt the user to add supports. The user should select not to add support structure as it will not be needed.

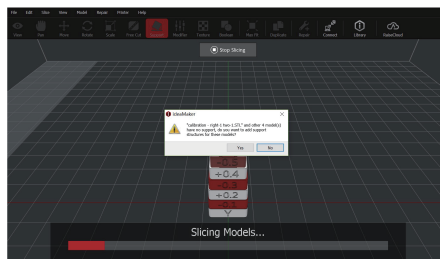

K. Dual Color Printing - Slicing

10 You can select your extruder and platform structure choice in the "Platform Additions" tab. These structures include: Raft, Brim, Skirt.
(Raft is not recommended to use for PVA and flexible filament.)

NOTE: You can edit the extruder's retraction amount under the "Ooze" tab. We recommend maintaining the "Extruder Amount of Extruder-switch" between 2-4 for standard filament types, and from 6-10mm for Raise3D Premium PLA.

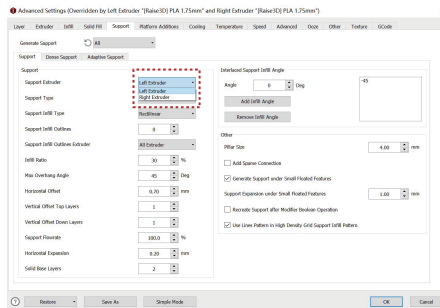

11 Wipe Wall

Enable Wipe Wall will add extra shell(s) around the model during dual-extruder printing. This wall(s) can help clean the oozing filament from the unused nozzle to reduce the effects of excess material on the final model.

Wipe Wall Offset refers to the distance between Wipe Wall and the outer shell of the model. If the wall is positioned too closely, the Wipe Wall may stick onto the model. If the wall is set too far, the wiping results may be affected.

Wipe Wall Angle refers to the maximum angle for generating the Wipe Wall. If the maximum angle is set too low, the wall may have a difficult time obeying the shape of the model, especially around curved surfaces.

Wipe Wall Loop Lines adjust the thickness of Wipe Wall.

Wipe Wall Type changes the shape of Wipe Wall. The difference among the following 3 types are the distance between Wipe Wall and the model.

Contoured type will generate a Wipe Wall structure with almost the same shape of the outlines of the model. In some cases, it will be too close to the model which may be difficult to remove especially with inner structures.

Water Fall will attempt to follow along the horizontal model contour.

Vertical will create a vertical wall at the height of the model. It is ideal for simple structures like tubes or cubes.

K. Dual Color Printing - Slicing

12 Dual-extrusion with Multiple Filament Types

Printing with multiple material types may limit printing compatibility. The table below lists all the officially-supported dual-extrusion material combinations currently possible on the Pro3.

LEGENDA	
✓	Officially supported
✗	Not supported
	Experimental

	PLA	ABS	Nylon	PC	TPU 95A	PETG	PVA
PLA	✓	✗	✗	✗	✗	✗	✓
ABS		✓	✗	✗	✗	✗	✗
Nylon			✓	✗	✗	✗	✓
PC				✓	✗	✗	✗
TPU 95A						✓	✗
PETG							✗
PVA							✗

13 PVA Print

When a nozzle has been selected to print with PVA, ideaMaker will automatically edit some additional settings for better performance with PVA. This will disable some settings under the "Advanced" menu and will not be directly editable. If you need to edit these settings, please open Printer > Filament Settings > PVA 1.75mm.

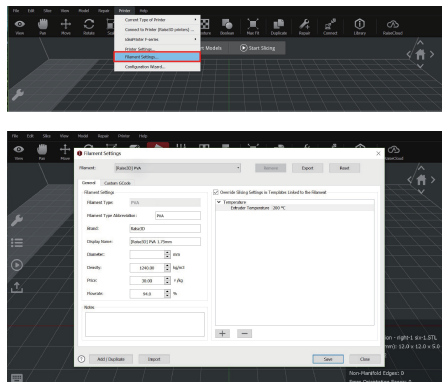

User Interface

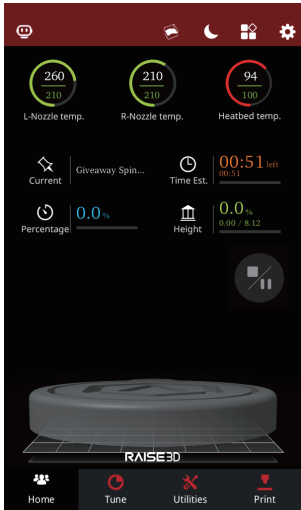

- Status Bar, EVE
- Menu title, Settings button
- Hot End and heated bed temperatures
- Current model name, total print time, current printing status and height
- Visual display of current model
- Pause/ Resume button
- Stop button
- Taskbar

Home

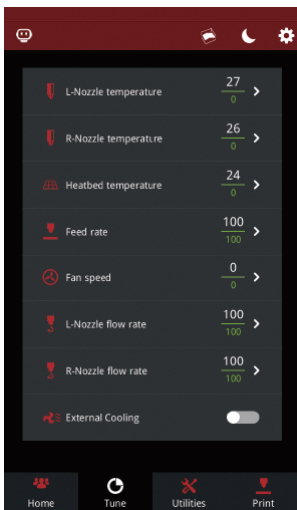

- Printing parameters and adjustments

Tune

User Interface

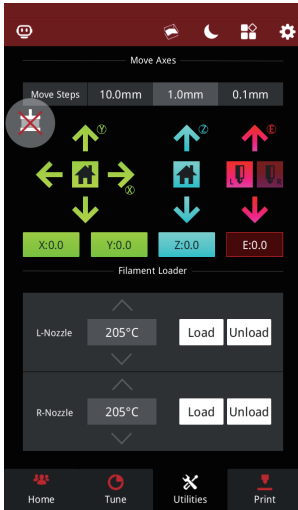

- Moving step distance setting

- Disable Motor button
- X/Y/Z axes move/home

- Load and unload function for the L&R extruders

Utilities

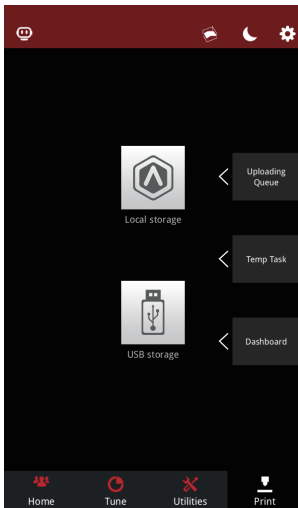

- Choose where to load the print job from

- Check uploading list, recovery task list, printing statistics

Print

*Contents of this brochure could be changed without written notice.

Experiencing Difficulties/Contact Information

If you run into any issues during this guided setup, please contact our expert technicians by opening a ticket online at support.raise3d.com.





US Office
43 Tesla, Irvine, CA 92618, USA

Netherlands Office
Stationsplein 45 Unit A4.004 3013AK Rotterdam, the Netherlands

China office
4th Floor B5, 1688 North Guoquan Raod, Yangpu District, Shanghai 200438

